

Model 172 PBM

High Performance Powered Subwoofer



 **Atlantic Technology**[®]
INNOVATIVE HOME THEATER

343 Vanderbilt Avenue Norwood, MA 02062 (781) 762-6300 www.atlantictechnology.com

Instruction Manual

MODEL 172 PBM

High Performance Powered Subwoofer



Congratulations on your purchase of an Atlantic Technology 172 PBM powered subwoofer. With proper care, your new subwoofer will provide many years of trouble-free performance.

The 172 PBM is capable of delivering very high output levels and wide dynamic range. When properly placed it will provide smooth in-room bass response down to approximately 20 Hz, with a peak SPL of 108dB (1800 cubic foot space).

The built-in proprietary high-current Class G amplifier is conservatively rated at 150 watts RMS. This amplifier, coupled with a massive 12" long-throw woofer in a sealed enclosure, generates musically accurate deep bass with a minimum of distortion.

Your Atlantic Technology powered subwoofer will smoothly integrate with virtually all other brands of loudspeakers on the market as all its internal electronics have been designed to maintain optimum signal integrity. From the premium quality gold plated connectors to the clearly marked controls, this is one of the most versatile high performance subwoofers you can buy. An added benefit is its relatively compact size and straight forward design.

Features

Your Atlantic Technology powered subwoofer has been engineered using the latest technology and finest components available. It features:

- **A long-throw 12" driver with vented motor structure and 2", high-temperature, 4-layer voice coil**
This powerful driver has a very stiff cone that acts as an almost perfect piston throughout its operating range. Its massive magnetic motor assembly and high temperature component parts deliver high performance and exceptional reliability. In fact, the 9.5 pound motor assembly is identical to the one in our top of the line 15 inch subwoofers!
- **A sealed enclosure for low distortion and deep bass output**
Sealed enclosure designs are inherently low in distortion and naturally deliver deep, smooth bass response with a gradual and predictable roll-off below resonance. As with all Atlantic Technology subwoofers, we have paid inordinate attention to giving you accurate musical bass reproduction along with terrific special effects.
- **A linear power high current Class G amplifier conservatively rated at 150 watts RMS**
Atlantic Technology's advanced Class G amplifiers utilize dual low voltage/high voltage power supplies for exceptional power delivery from a compact and efficient package. One power supply operates during all "normal" demand periods. But, when a high demand peak signal appears at the subwoofer input, the second, high voltage supply switches in to dramatically boost the amplifier's low distortion output capability. The amplifier delivers very high power levels yet consumes less steady-state power and produces much less heat than standard comparable amplifier designs. The 172 PBM's custom designed amplifier has been precision matched and equalized to its 12" driver. It exerts accurate and powerful control over the driver for the best performance possible.

- **A useful in room working frequency range of 20Hz to 150Hz**
- **A unique Dual Diversity Crossover™ (DDC) system with an adjustable (50Hz to 150Hz) 12dB per octave low-pass crossover, and a fixed 24dB per octave “voice filter” at 180Hz.**
 This sophisticated crossover’s upper end roll-off slope is an extremely steep 12dB + 24dB per octave, totaling 36dB per octave above 180Hz. It allows for exceptional integration with most any brand or type of speaker on the market. We have developed this unusual design to eliminate any possibility of out-of-band information being audible from the subwoofer and thereby making it localizable.

The DDC filter is incorporated to allow this subwoofer to match well with compact home theater speaker systems. If you are using a subwoofer with extremely small satellites which have limited mid-bass output you’ll need to cross over the subwoofer at a fairly high frequency. Since very compact Left / Right / Center speakers typically aren’t capable of delivering significant output below 100 to 125Hz, their mating subwoofer must reproduce these sounds. However, it’s critically important that all sounds above this frequency be eliminated from the subwoofer, in order to get correct system integration. This is because higher frequencies are your ears’ clues to where sound comes from. The innovative DDC 36dB crossover in the 172 PBM ensures precise and seamless system integration with compact satellite speakers. A subsonic filter is also incorporated to eliminate inaudible ultra-low frequencies that can rob amplifier power.

Figure 1:
 Amplifier panel
 and controls
 Model 172 PBM



IMPORTANT NOTE - Only if you are NOT using the complete System 170: *If you are using a surround receiver/processor that includes its own filtered subwoofer output and ultra-compact satellites, we strongly recommend that you connect the 172 PBM to your system using the high level (speaker) inputs. This is because most receiver/processor internal crossovers are 12dB per octave, which isn't steep enough for use with the higher crossover levels required for ultra-compact satellites. In such a case, only use the low level RCA inputs when the processor outputs unfiltered signals. Should your processor include a 120Hz crossover, and a slope of 18dB or higher, you may connect it to the low level inputs on the 172 PBM.*

- **Two line inputs, two line thruputs**
The thruputs allow daisy chaining of multiple subwoofers, or can act as a return path back to the processor.
- **Two high level inputs, two high level thruputs**
These let you connect the subwoofer to your amplifier using the amplifier's speaker outputs. Once again, you can daisy chain to another subwoofer using the unmodified signal that comes out of the thruput connectors.
- **A Phase Invert toggle switch (Normal/Invert)**
This switch allows precise acoustic matching with speaker systems whose output may be phase reversed. This switch also allows you to compensate for unusual room acoustics that occur when a woofer is physically separated from the midrange/high frequency units. Be sure to try the Phase switch in both positions when you set up the 172 PBM. Even if you just change the built-in crossover settings it's a good idea to try the Phase switch in both positions, since the crossover control and the Phase switch acoustically interact with each other.
- **A front panel mounted level control**
- **Automatic standby operation**
Automatic standby features automatic signal sensing turn on and a 7-10 minute turn-off delay. There's a front panel multi-color LED status indicator.
- **An AC cord power input socket**
Your subwoofer comes supplied with a heavy-duty detachable power cord.
- **Designed and built to meet all UL/CSA and European safety requirements**

Connecting Your Subwoofer

The Atlantic Technology System 172 PBM Powered Subwoofer is simple to hook up, offering several connection methods for maximum flexibility. Study the system diagrams starting on page 5. Once you have found the example which most closely matches your system, hook up your subwoofer(s) as shown in that diagram.

Low-Level Connection

If you have purchased the entire System 170, we suggest using the low-level (RCA jack) subwoofer line out or preamp output if your receiver/processor has one. Simply connect your subwoofer with high quality shielded cables as shown in the diagrams. Use the diagram that best suits your connection requirements.

**Example 1:
Subwoofer
Line Out/
Low Level In**

Before using this connection method, please see the Important Note on page 4.

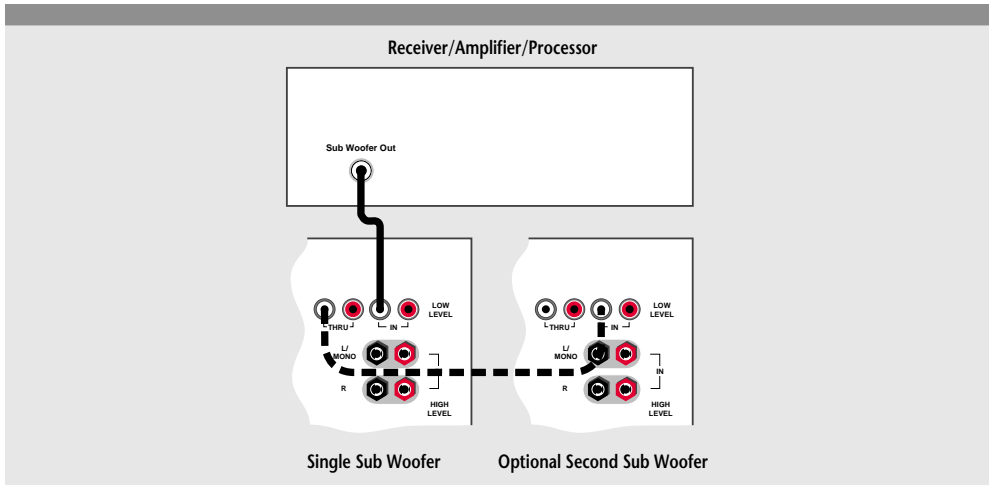

**Example 2:
Preamp Line
Out/Low
Level In for
1 Subwoofer**

This arrangement is for owners of stereo receivers/amplifiers with Preamp outputs. If your receiver/amplifier uses jumper links between the Pre-out and Main In, then you must remove them and use option 1 or 2. If your receiver/amplifier uses a switch instead of connectors, then use option 3.

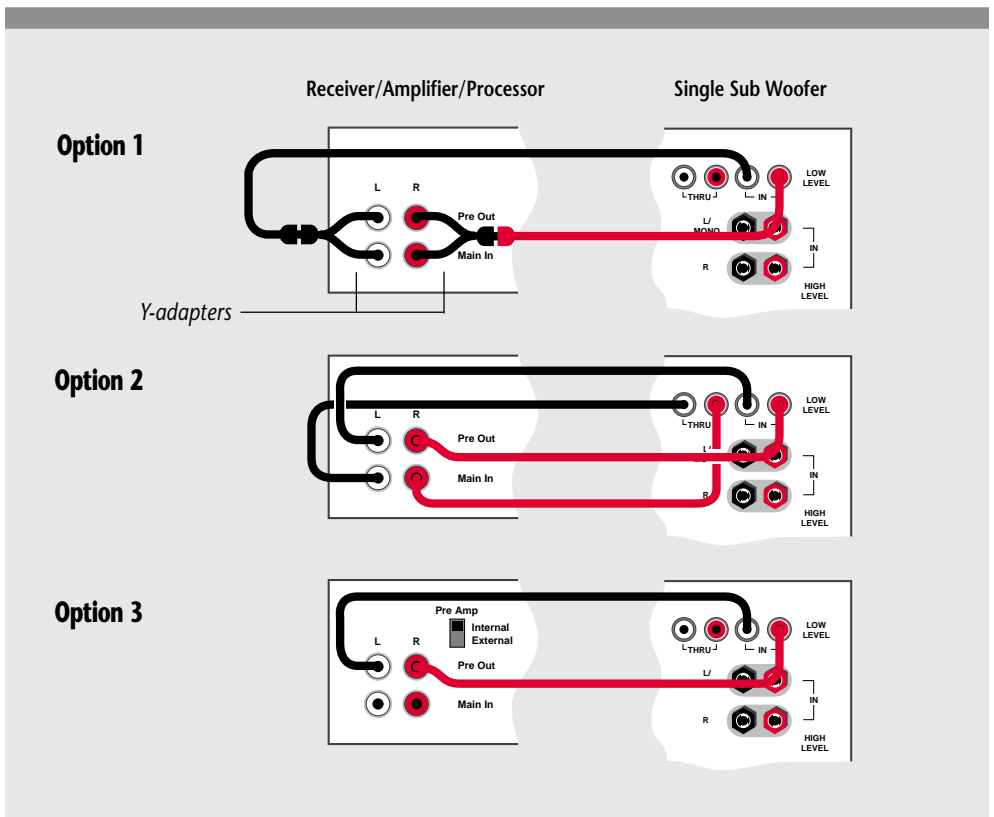

**Example 3:
Preamp Line
Out/Low Level
In for
2 Subwoofers**

Note that the L/MONO input is used on both subwoofers. Instead of Y-adapters, you may also use the THRU outputs to connect back to the Main Inputs as shown in Option 2 of Example 2.

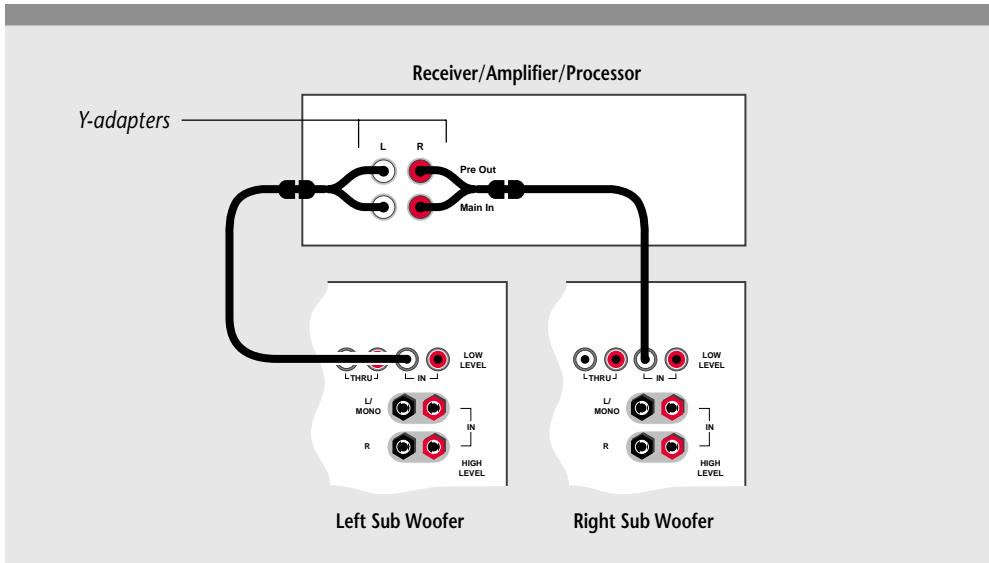

**Example 4:
Speaker Out/
High Level In for
1 Subwoofer**

This is the recommended method for connecting the 172 PBM to a discrete 5.1 channel. Please the Important Note on page 4.

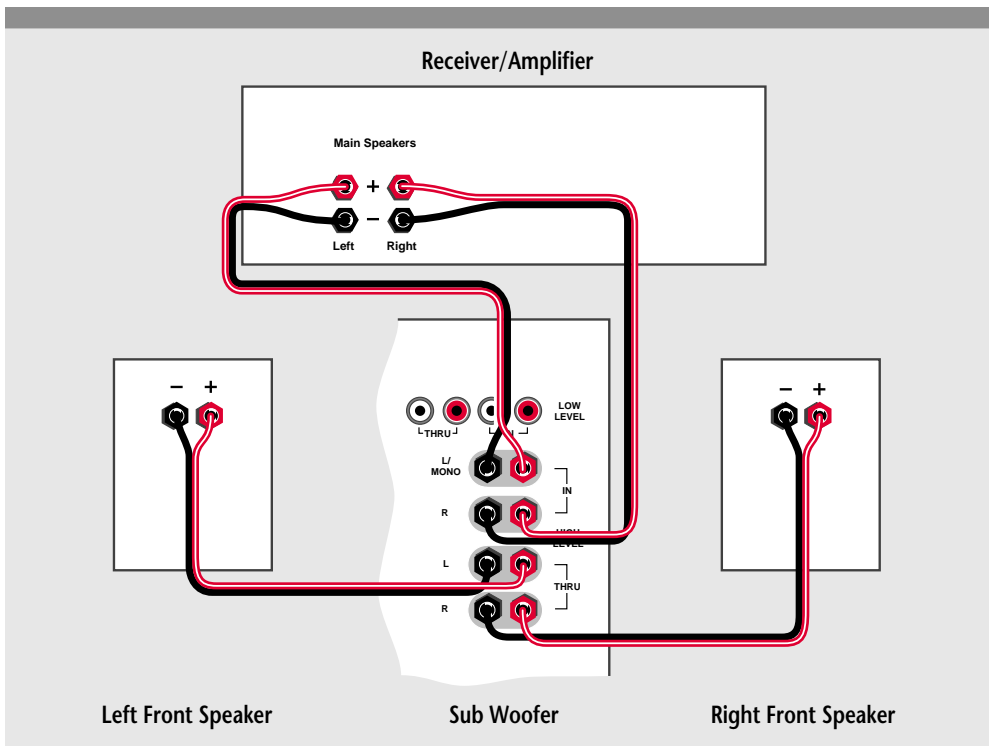

**Example 5:
Speaker Out/
High Level In for
2 Subwoofers**

This is the recommended method for connecting the 172 PBM to a discrete 5.1 channel receiver or amplifier. Please see the Important Note on page 4. You can also use the speaker level THRU outputs. Note that the L/MONO High Level input is used on both left and right subwoofers.

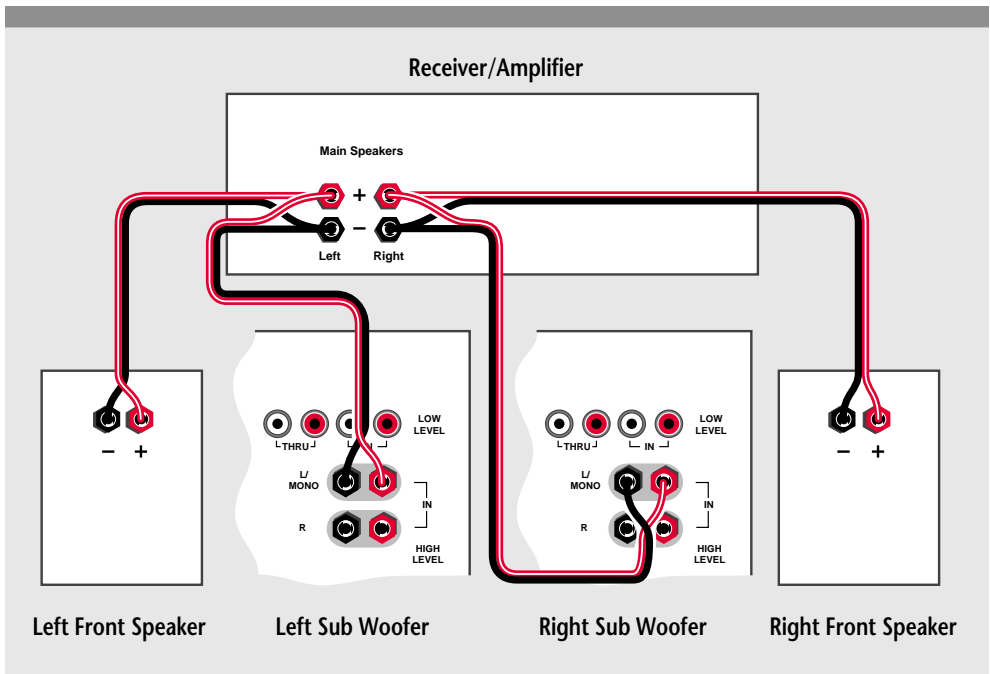

Using the Low-level Thruput

If desired, you can run a line level stereo signal through the 172 PBM and out to another unit. This way you can add an additional subwoofer with minimal additional wiring. The signal that comes out of the Thruput jacks is identical to the input signal.

High-Level Connection

Alternately, you may use the high-level (speaker) inputs. As mentioned above, we strongly suggest you use the High-level inputs if you are using ultra-compact satellite speakers that have little or no output below 125 Hz. We recommend that you connect your new 172 PBM Powered Subwoofer(s) using high quality wire of 16 gauge or larger. There are many respected manufacturers in the audio industry that specialize in speaker wire and interconnect cables suitable for your new system. Please consult your audio/video specialist for more specific information.

High-level Thruput

If desired, you can run a high level stereo signal through the 172 PBM and out to another unit. This way you can add an additional subwoofer with minimal additional wiring. The signal that comes out of the Thruput jacks is identical to the input signal.

Warning: To prevent risk of electrical shock or damage to your equipment, always unplug all component AC cords before proceeding with speaker and component connections! The last step in wiring your system should be plugging in the AC cords!

Note: Due to the very close placement of the High-level connectors, the most practical connectors to use are “double banana plugs” (North America only) available from most electronic supply stores.

You can connect to the High-level inputs by using a variety of connectors, or by removing 1/2" of insulation from each wire end, twisting the strands of wire together, placing the wire through one of the post holes and screwing down the nut tightly. We recommend that you check your local electrical codes to make sure you are not using an improper connector.

Figure 2:
Gold plated
5-way binding
posts. Accepts
up to 10 gauge
bare wire

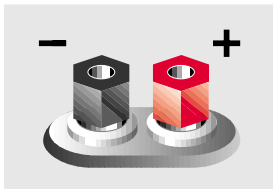

It is important to observe polarity while making speaker connections: red (+) terminals on the amplifier to red (+) on the speaker, black (-) on the amplifier to black (-) on the speaker. Look carefully at the wires you are using and note that one of the wires in each pair will be marked by either the conductor color, printing on the wire jacket, a ridge on one side of the wire jacket, or a thread intertwined with the wire strands. By convention, the marked wire is connected to the red (+) terminal.

Power Connection

Connect the power cord to an AC outlet only after making all other connections to the subwoofer. This will avoid any chance of accidentally activating the subwoofer while wiring. Atlantic Technology **does not recommend** plugging the subwoofer into the switched outlet of an amplifier, preamplifier, or receiver. The power demands of the subwoofer amplifier may exceed the power rating of the switched outlet and may damage the equipment.

The 172 PBM is totally automatic in its operation. The automatic on/off circuitry will only activate the subwoofer in the presence of an audio signal from your audio/video system. After 7-10 minutes with no signal detected from the rest of the system, the amplifier will shut itself off and go into standby mode. When an audio signal is present, the power LED located under the front grille will glow green. Power consumption in the standby mode is negligible. Standby operation can be completely bypassed by plugging the 172 PBM into a heavy-duty switched power outlet strip if you desire. In this mode, the subwoofer will be powered when the power switch is turned on and it will still operate in automatic standby/on mode when the power strip is active.

Placement and Operation

Generally speaking, the best location for your new Subwoofer will be in the front of the room, in or close to a corner (Figure 3). Every room has its own unique sound characteristics, and flexibility in the exact placement of the subwoofer is always desirable. The closer the subwoofer is placed to a wall and especially a corner, the more and deeper the bass response you will hear. However, in some rooms, corner placement can produce too much bass or a “one note” boomy effect. Under such circumstances the subwoofer may work better away from the corner. You should experiment to find the best position in your room.

Helpful Hint: A particularly useful experiment is to place the subwoofer right at the prime listening position (move that couch or chair out of the way and put the sub in its place). Then play something with lots of good bass (preferably music), and walk around the room, listening to the subwoofer’s response. When you locate an area that has ample amounts of well defined bass you have found a good potential place to locate the sub.

Figure 3:
Typical arrangement for a single subwoofer in a home theater.

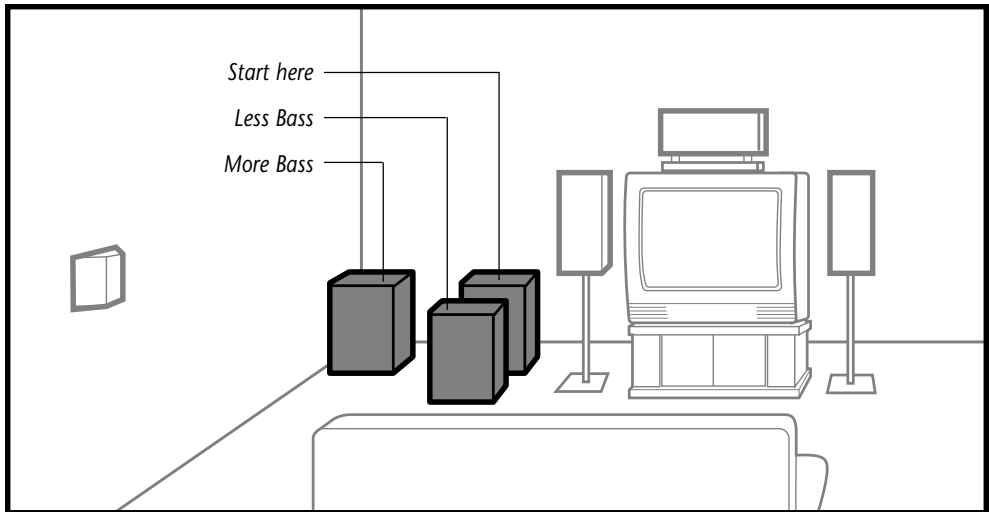

Subwoofer Tuning Using the Variable Level Control

Start your listening with the subwoofer Lo-pass control set at approximately 1/3 of its range (which corresponds to 90Hz), the phase switch set to normal, and the front panel variable level control (Figure 5) set to the bottom of its range (fully counterclockwise facing the front of the woofer). Play some music that you know has good bass content, and turn the level control up until you just start to hear the subwoofer working. Now, from your normal listening position, determine whether the subwoofer is playing loudly enough and filling in the bass frequencies of the music evenly. If adjustment is necessary, start by changing the setting of the front panel level control to compensate.

Figure 4:
Front Panel Variable Level Control located behind the removable grille.



If the bass seems too heavy, move the subwoofer away from the wall/corner. If the bass seems too thin, move the subwoofer closer to the wall/corner. Small differences in positioning can make big differences in bass response. When you find a position that seems to work well, try switching the phase switch between its two settings, listening particularly to the transition from the subwoofer to the satellites.

Sometimes people prefer more bass impact for movies than sounds natural when reproducing music. You may wish to determine both a video level and an audio level if you find yourself falling into this camp. Remember however, the most common error people make when setting up their system is to play the subwoofer too loudly. Of course, the Bass Police will not arrest you for this act. But should you desire the most accurate overall reproduction, a well balanced sound from bass to highest treble is the best way to get it. Have fun. Experiment. Enjoy.

Dual Subwoofer Placement

When two subwoofers are used you may wish to place them asymmetrically; that is, in slightly different positions in the room (Figure 5). This will reduce common mode room resonances that are common to symmetrically positioned subwoofers. You can also try placing the subwoofers in the same corner, if you wish, Experiments have shown this to be a viable means of producing smooth bass response in many rooms.

Figure 3:
Typical arrangement for a single subwoofer in a home theater.

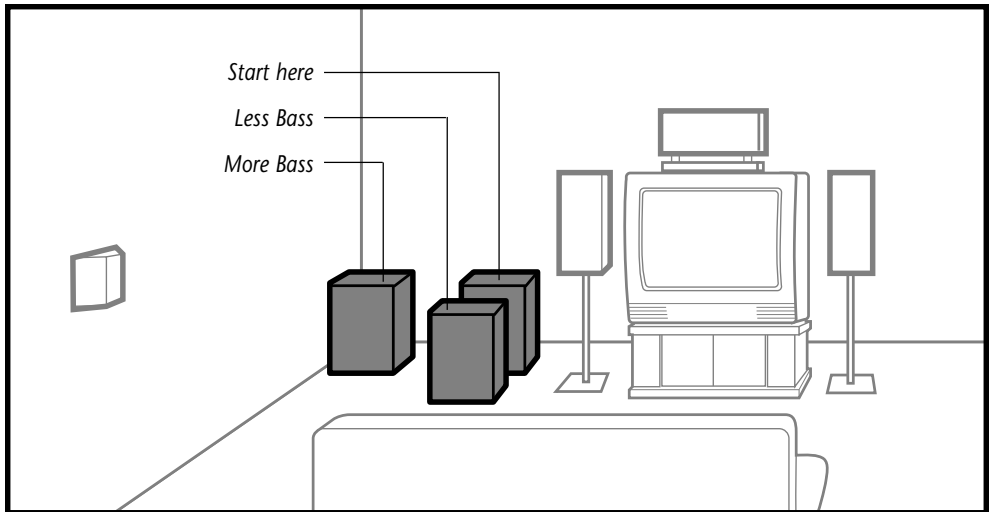

Subwoofer Tuning Using the Variable Level Control

Start your listening with the subwoofer Lo-pass control set at approximately 1/3 of its range (which corresponds to 90Hz), the phase switch set to normal, and the front panel variable level control (Figure 5) set to the bottom of its range (fully counterclockwise facing the front of the woofer). Play some music that you know has good bass content, and turn the level control up until you just start to hear the subwoofer working. Now, from your normal listening position, determine whether the subwoofer is playing loudly enough and filling in the bass frequencies of the music evenly. If adjustment is necessary, start by changing the setting of the front panel level control to compensate.

Figure 4:
Front Panel Variable Level Control located behind the removable grille.



If the bass seems too heavy, move the subwoofer away from the wall/corner. If the bass seems too thin, move the subwoofer closer to the wall/corner. Small differences in positioning can make big differences in bass response. When you find a position that seems to work well, try switching the phase switch between its two settings, listening particularly to the transition from the subwoofer to the satellites.

Sometimes people prefer more bass impact for movies than sounds natural when reproducing music. You may wish to determine both a video level and an audio level if you find yourself falling into this camp. Remember however, the most common error people make when setting up their system is to play the subwoofer too loudly. Of course, the Bass Police will not arrest you for this act. But should you desire the most accurate overall reproduction, a well balanced sound from bass to highest treble is the best way to get it. Have fun. Experiment. Enjoy.

Dual Subwoofer Placement

When two subwoofers are used you may wish to place them asymmetrically; that is, in slightly different positions in the room (Figure 5). This will reduce common mode room resonances that are common to symmetrically positioned subwoofers. You can also try placing the subwoofers in the same corner, if you wish, Experiments have shown this to be a viable means of producing smooth bass response in many rooms.

Figure 5:
Asymmetrical arrangement for 2 subwoofers in a home theater, for example, one closer to a corner than the other.

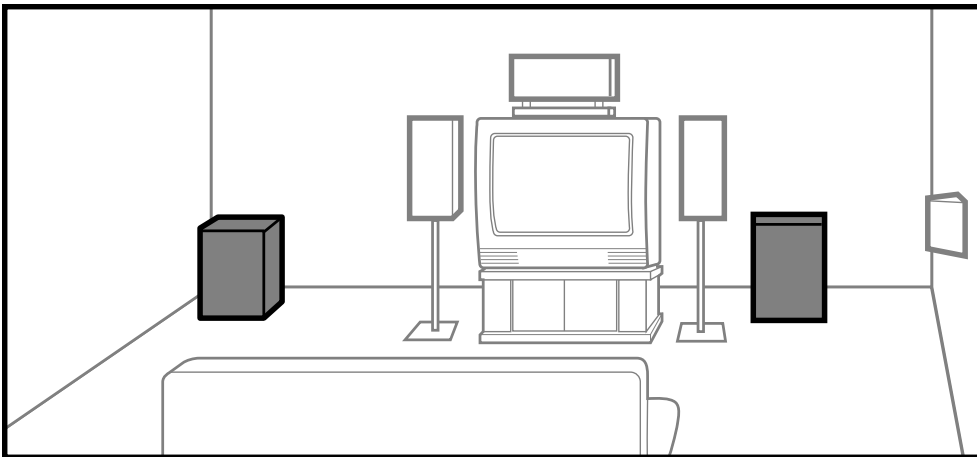

Using the Subwoofer Lo-Pass Control

When used with the complete System 170, the 172 PBM Lo-pass control should be set at 1/3 of its range to begin with. The goal is to optimize the performance of the system by ensuring that the subwoofer and satellites produce a cohesive and well integrated sound “picture.” The low frequency response of the System 170 satellites has been optimized to work with approximately a 90Hz crossover point. This provides maximum performance and smooth integration with the subwoofer.

Higher crossover frequencies pass more bass but can sound boomy and may be more easily localized to the subwoofer. Higher crossover frequencies may be suitable, however, when using very small satellites that have no real low frequency performance. Settings lower than 90Hz should be employed if you are using larger speakers that have extended bass response. This way, the subwoofer will only reproduce the very lowest bass frequencies that are in the range where the large main speakers begin to roll off. It’s generally undesirable to have the main speakers and the subwoofer overlap too much. Larger speakers means a lower Lo-pass crossover frequency, smaller speakers means a higher Lo-pass crossover frequency. Consult the manufacturer’s specified low frequency response for your main speakers to determine the appropriate Lo-pass setting on your subwoofer. In the end, however, a little time spent experimenting will generally result in dramatically better bass response.

The Phase Invert Control

A subwoofer operating out of phase with the rest of the system won’t provide optimum low frequency performance. Also, the correct subwoofer phase can enhance room acoustics. Since there is so much variation in the industry regarding phase, and no standards have been established, a switch that will reverse the phase of the subwoofer is provided on the amplifier panel. Listen to a monaural musical source with strong bass content. (For example, you can use the mono switch on an FM tuner or preamp, or use a Y-connector on the outputs of one of your source components to get a mono signal.) Experiment with the position of the phase switch to get the most extended bass. It should be obvious which is the correct setting. In particular, there will be a smoother more integrated transition between the satellites and the subwoofer when they are properly phased.

Model 172 PBM Specifications

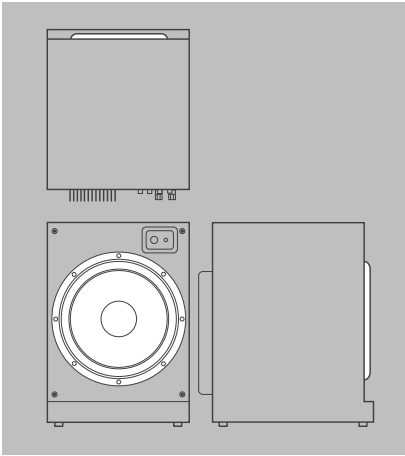

Type/Features	Powered Subwoofer with Sealed Acoustic-Suspension Enclosure Variable 50-150 Hz, 12 dB/Octave low pass output Fixed 24 dB/Octave 180 Hz Low-Pass Filter Dual Diversity Crossover System (DDC) [™]
Driver	(1) 12" long-throw woofer, 2", 4 layer vented aluminum voice coil, vented motor system
Amplifier Power	150 Watts RMS all discrete linear Class G power amplifier with dual power supplies
Amplifier Distortion	<0.025%
Frequency Response	20-180 Hz \pm 3dB
Peak output (SPL)	108dB
Dimensions	13.8in x 19.7in x 13.8in; 350mm x 500mm x 350mm
Weight	42.75lbs.; 19.4kg.

Specifications are those in effect at the time of printing. Atlantic Technology reserves the right to change specifications or designs at any time without notice. Dolby Digital, AC-3, Dolby Stereo and Dolby Pro Logic are trademarks of Dolby Laboratories Licensing Corporation. DTS is a registered trademark of DTS Technology.

For Future Reference

Record your speaker serial number and date of purchase here:

Model Number _____ Serial Number _____ Date of Purchase _____

The serial number is found on the back of the speaker near the connecting terminals.



CAUTION: To reduce the risk of electric shock, do not remove the cover (or back). No user serviceable parts inside. Refer to qualified personnel.

WARNING: To reduce the risk of fire or electric shock, do not expose this appliance to rain or moisture.



The lightning flash with arrowhead, within an equilateral triangle, is intended to alert the user to the presence of uninsulated "dangerous voltage" within the product's enclosure that may be of sufficient magnitude to constitute a risk of electrical shock to persons.



The exclamation point within an equilateral triangle is intended to alert the user to the presence of important operating maintenance (servicing) instructions in the literature accompanying the appliance.